

**INSTRUCTION MANUAL**  
**VIBRASWITCH**  
**MODEL EURO 366**  
**EXPLOSION PROOF, ATEX**  
**Ex d IIC T6 IP66 T85°C**



**Robertshaw**

Industrial Products Division  
1602 Mustang Drive  
Maryville, Tennessee 37801  
Phone: (865) 981-3100 Fax: (865) 981-3168  
<http://www.robertshawindustrial.com>

**INSTRUCTION MANUAL NUMBER**

**909GF293F**

## RECORD OF CHANGES

Revision	Design Engineer's Approval	Engineering Manager's Approval	Approval Date	COS Number	Brief Description
D	<i>P. Kronau</i>	<i>Brien Evans</i>	31JUL08	96644	Updated Model Number breakdown to agree with PS sheet, added Record of Changes, deleted Figure 3-4 & reformatted.
E	<i>P. Kronau</i>	<i>Brien Evans</i>	16APR09	96739	Updated photo on cover page. Corrected title of Figure3.3. Corrected description for Table 3, Designation H. Delete weight for CPSC, changed EFSRC to CS-INVR366, updated Certificate number. Updated Figure 3.3. Updated Section 6.1.
F	<i>P. Kronau</i>	<i>Brien Evans</i>	20JUL10	96781	IP66 was IP65

## TABLE OF CONTENTS

SECTION	PAGE
<b>I DESCRIPTION .....</b>	<b>4</b>
1.1 Description .....	4
1.2 Model Identification .....	4
<b>II SPECIFICATIONS .....</b>	<b>7</b>
2.1 Environmental .....	7
2.2 Performance .....	7
<b>III INSTALLATION .....</b>	<b>8</b>
3.1 General .....	8
3.2 Mounting .....	8
3.3 Terminal Block .....	9
3.4 Space Heater .....	10
3.5 Wiring .....	10
3.6 Mounting Dimensions .....	13
<b>IV OPERATION.....</b>	<b>14</b>
4.1 Operation.....	14
4.2 Adjustment of Operating Setpoint .....	15
<b>V MAINTENANCE .....</b>	<b>18</b>
5.1 Troubleshooting .....	18
<b>VI ATEX.....</b>	<b>20</b>
6.1 Special ATEX Use and Maintenance.....	20

## LIST OF ILLUSTRATIONS

FIGURE	PAGE
3-1 External Wiring for Vibraswitch Model EURO 366 .....	9
3-2 Methods of Mounting the Vibraswitch Model EURO 366.....	12
3-3 Mounting Dimensions for Vibraswitch.....	13
4-1 Operating Principle for the Vibraswitch Model EURO 366.....	14
4-2 Setpoint Adjustment.....	16
4-3 Setpoint Alarm Settings .....	17

## SECTION I DESCRIPTION

### 1.1 DESCRIPTION

The Vibraswitch, Model EURO 366, is designed to protect rotating, reciprocating, or similar equipment against serious damage from malfunctions that can be detected as an increase in vibration. A reset and holding coil is provided, in the DC/AC voltage as specified so that accidental shutdowns on start can be prevented.

The Vibraswitch, Model EURO 366, may be used in conjunction with the Vibraswitch Monitor, Model 563A. The Monitor is a solid-state electronic system designed to "sort-out" false signals received by the Vibraswitch so that Alarm and/or Shutdown of the operating machine will not result from false, transient disturbances. Please note that the Model 563A does not have CE or ATEX certification at this time.

### 1.2 MODEL IDENTIFICATION

Specify and order instrument models in accordance with the description and variations listed in each table.

#### Key Model Number Example

**EURO 366 – A 8 – H 1 – A – F X - X**

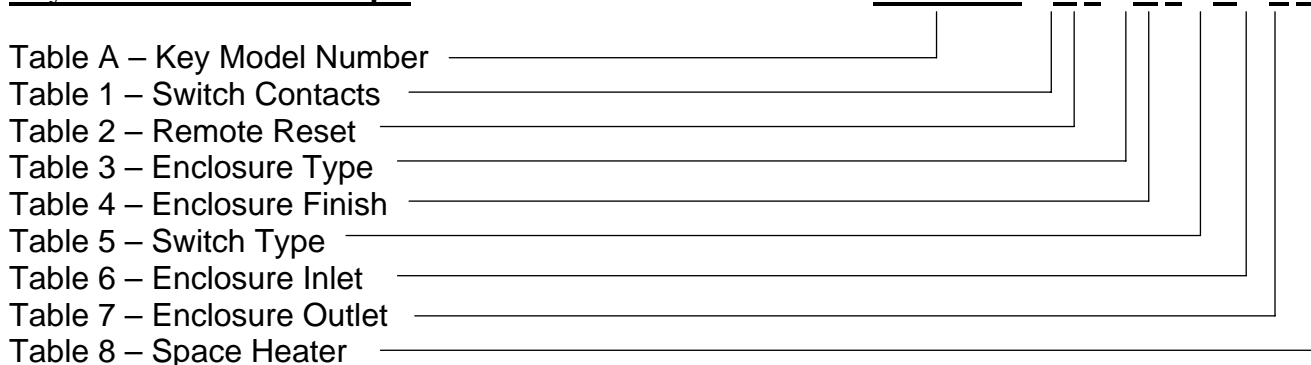

**Table A - Key Model Number**

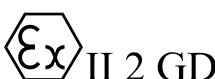
Model Number	Description
<b>EURO 366</b> 	Electric Vibration Detector. Explosion Proof Atex EEx-d-IIC-T6 IP66 T85°C Contacts actuate when Setpoint is exceeded. Range: from 0 to 4,5

**Table 1 - Switch Contacts**

Designation	Description
<b>A</b>	SPDT - Single Pole, Double Throw load contacts.
<b>D</b>	DPDT - Double Pole, Double Throw load switches.

**Table 2 - Remote Option Reset**

Designation	Description
<b>0</b>	<b>No Reset Coil</b>
<b>2</b>	<b>24</b> Volt DC reset coil voltage
<b>4</b>	<b>48</b> Volt DC reset coil voltage
<b>7</b>	<b>120</b> Volt DC reset coil voltage
<b>8</b>	<b>120</b> Volt AC reset coil voltage
<b>9</b>	<b>240</b> Volt AC reset coil voltage

**Table 3 - Enclosure Type**

Designation	Description	Remarks
<b>H</b>	CS-INVR366.....T.cable 105°C & T.amb. -30 to +55°C	

**Table 4 - Enclosure Finish**

Designation	Description
<b>1</b>	Unpainted (Sandblasted)
<b>2</b>	Polyurethane Painted Olive Drab (Tecnocolor RAL 6003)

**Table 5 – Switch Type**

Designation	Description	Protection	Remarks
<b>A</b>	7,0 Amp max. 460 VAC max. NI 0,5 Amp at 120 VDC 1,0 Amp at 48 VDC 2,0 Amp at 24 VDC	IP50	Use with Table 1, Designation A, only
<b>E</b>	5,0 Amp at 250 VAC max. NI 5,0 Amp at 30 VDC max.	IP50	Use with Table 1, Designation D, only
<b>H*</b>	0,1 Amp max. at 250 VAC 0,1 Amp max. at 125 VAC 0,1 Amp max. at 30 VDC 5,0 mA min. 6 VDC max. 2,0 mA min. 12 VDC max. 1,0 mA min. 24 VDC max.	IP67 (Sealed)	Use with Table 1, Designation D, only

\* Gold Plated Contacts, suitable for Intrinsic safety Applications

**Table 6 – Enclosure Inlet**

Designation	Description	Remarks
F	¾" UNI Plug	

**Table 7 – Enclosure Outlet**

Designation	Description	Remarks
X	Standard ¾" UNI 6125	

**Table 8 - Space Heater**

Designation	Description
F	24 VDC 2 Watt
G	48 VDC 2 Watt
H	120 VAC 2 Watt
L	120 VDC 2 Watt
M	240 VAC 2 Watt
X	No Space Heater

NOTE 1 – ¾" UNI OPENING WILL ALSO ACCEPT ¾" NPT FITTINGS.

NOTE 2 – PLUG MAY BE DISCARDED, IF NOT REQUIRED.

## SECTION II SPECIFICATIONS

### 2.1 ENVIRONMENTAL

Housing .....	Cast Aluminum UNI 4514 Alloy
Weight Model CS-INVR366.....	2,2 Kg
Enclosure Classification.....	EEx-d-IIA/B/C-T6 IP66 T85°C
Certificate No. ....	CESI 03ATEX186
Enclosure Protection.....	IP66
Enclosure Sealing.....	Neoprene O-ring
Location: Mounting.....	Outdoors, Unprotected
External Bolts.....	Stainless Steel
Nameplate.....	Stainless Steel
Conduits.....	2 x 3/4" UNI 6125-74
Enclosure Finish .....	Sandblasted (Standard)
	Polyurethane painted olive drab Tecnocolor RAL 6003 (optional)
Ambient Temperature Limits.....	-30°C to +55°C
Humidity.....	To 95% Relative Humidity @ +37,7°C
Shock .....	40 g @ 11 ms. maximum

### 2.2 PERFORMANCE

Vibration Measurement Range .....	0 to 4,5 g from 0 to 300 Hz
Setpoint Range .....	0 to 4,5 g when mounted horizontal 0 to 3,5 g when mounted vertical
Setpoint Adjustment.....	1 turn per g
Accuracy.....	±5% of full range (0 to 300 Hz)
Ambient Temperature Effect.....	±10%/100°F (55,5°C) maximum

#### Reset Coil

Standard Voltages .....	24 VDC, 0,5 A 48 VDC, 0,2 A 120 VDC, 0,14 A 120 VAC, 0,3 A, 50/60 Hz 240 VAC, 0,3 A, 50/60 Hz
Duty Cycle (24 VDC, 48 VDC, 120 VDC, 120 VAC).....	4 minutes <b>max. ON</b> - 10 minutes <b>min. OFF</b>
Duty Cycle (240 VAC).....	1 minute <b>max. ON</b> - 10 minutes <b>min. OFF</b>

## SECTION III INSTALLATION

### 3.1 GENERAL

Examine the instrument for possible shipping damages. **IMPORTANT:** If for any reason it is determined that the equipment should be returned to the factory, please notify the nearest Robertshaw Industrial Products sales representative prior to shipment. Each unit must be properly packaged to prevent damage. Robertshaw assumes no responsibility for equipment damaged in shipment due to improper packing.

Choose the location in accordance with good instrument practice, avoiding extremes of temperature, humidity and vibration. (See SPECIFICATIONS, Section II.)

The Vibraswitch, Model EURO 366, malfunction detector may be located in any outdoor or indoor area according to ATEX Classification and housing Protection information contained in Section II, Specifications. In locations where moisture condensation within junction boxes is a problem, for Vibraswitches with a SPDT switch (Table 1, Designation A) a two watt resistor may be placed across terminals 6 and 8 inside the Vibraswitch enclosure and wired to a source of continuous voltage to provide heat within the enclosure to reduce condensation effects. See Table 3-1 for Space heater value. Space heater resistors cannot be readily installed in the field in Vibraswitches with a DPDT switch (Table 1, Designation D).

### 3.2 MOUNTING

Figure 3-2 illustrates the methods of mounting on various pieces of equipment. Figure 3-1 shows the mounting dimensions and external wiring for the Vibraswitch Model EURO 366.

The vibration sensitive axis of the Vibraswitch is perpendicular to its mounting base. Therefore, the Vibraswitch must be mounted in a plane that will detect the vibratory motion for which protection is desired. The Vibraswitch may be mounted at any location along the length of machines containing rotating shafts that are horizontal and parallel to the base of machine: the preferable location being in line with the rotating shaft. Do not mount the Vibraswitch perpendicular to the ends of the rotating shafts unless the end-play or end-thrust measurement is desired. Normally, bent shafts, unbalances on the rotating mass of the shaft, worn bearings, and other anomalies are detected near the bearing housing and at the right angles to the shaft.

The Vibraswitch may be mounted in any position between the side (vertical) or the top (horizontal) of bearings or machine housing. It should be noted that when mounting Vibraswitches on top (horizontal position) of equipment the vibration measurement range is stated in the Specification Section. However, when the Vibraswitch is mounted on a side position (90° from horizontal), 1 g is subtracted from the measurement range of the instrument.

If mounting bracket assembly is used to mount the Vibraswitch due to an irregular mounting surface, it must be constructed of steel having sufficient thickness and properly reinforced so that mechanical resonance are not introduced; usually ½" steel plate is satisfactory if the dimensions of the bracket are not large. It is extremely important that all four corners of the Vibraswitch, as well as the mounting assembly, be rigidly secured to the machine. Exact location is not critical as the adjustment procedure of the Vibraswitch automatically accounts for the normal vibration at the location.

The Vibraswitch, when properly adjusted, trips on a relative increase in vibration.

When installing the Vibraswitch on existing equipment where several convenient mounting positions are available, it is advisable to check the existing vibration level at each possible position before permanently mounting the unit. The Vibraswitch can be used to measure existing vibration by holding or clamping it against the running machine and determining the trip point as described under "ADJUSTMENT" in this manual. Should normal vibration exceed the range of the Vibraswitch, it is recommended that consideration be given to Vibra-Tel, Model 566, Continuous Monitor Unit which is capable of monitoring higher g-levels. Please note that the Model 566 does not have CE or ATEX certification at this time.



### 3.3 TERMINAL BLOCK

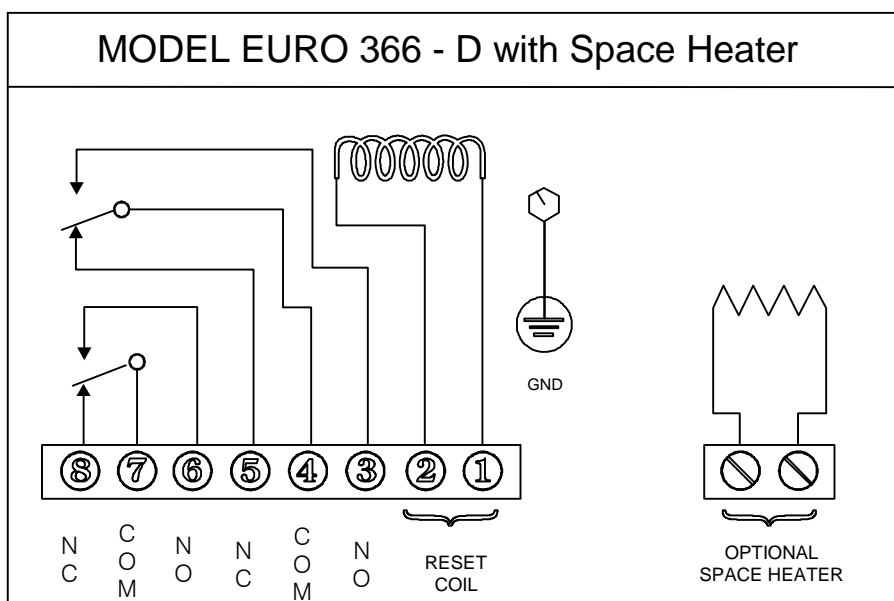
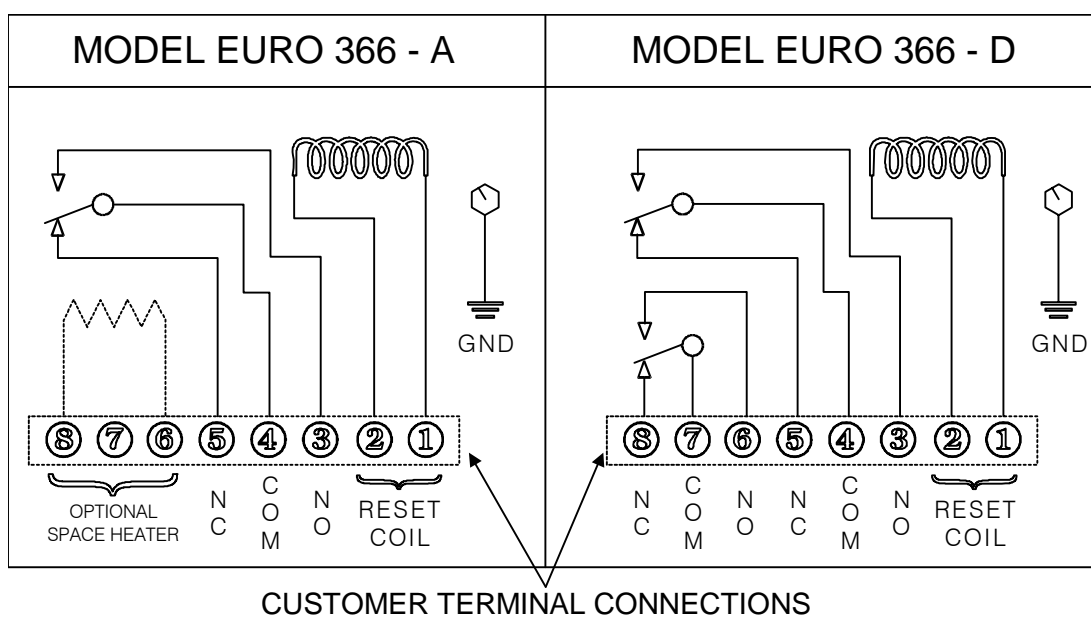

**Figure 3-1. External Wiring for the Vibraswitch, Model EURO 366.**

#### NOTES:

1. Switch shown in normal or reset position - reverses on actuation from increased vibration.
2. Standard Coil Voltages: 24 VDC, 48 VDC, 120 VDC and 120 VAC (240 VAC Optional).
3. Heater resistor installed, when required, to prevent condensation in housing where climate conditions require. (Supplied only when specified)
4. If Manual Reset Only is desired, do not apply power to the reset coil.

### 3.4 SPACE HEATER

In some outdoor installations, it may be necessary to install a space heater to prevent moisture condensation. For Vibraswitches with a SPDT switch (Table 1, Designation A) a small conventional carbon 2 watt resistor should be installed across terminals 6 and 8 in the detector. Proper values are shown in Table 3-1. Space heaters cannot be readily installed in the field in Vibraswitches with a DPDT switch (Table 1, Designation D).

**Table 3-1. Space Heater Resistor Values**

VOLTAGE (DC or AC)	SPACE HEATER RESISTOR (OHMS)
460	220.000
240	56.000
120	12.000
48	2.000
24	560

### 3.5 WIRING

The Vibraswitch, Model EURO 366, is equipped with two threaded hubs for 3/4" UNI-6125-74 conduit. When the vibration amplitude is large (i.e., greater than 5 mils) it is good practice to use a short length of flexible conduit to serve as an insulator between the rigid conduit and the Vibraswitch. Wiring into the unit should be done with #18 stranded wire although #14 can be used where necessary. The Vibraswitch was not designed for wiring with heavy solid wire. However, where necessary to use an heavier wire, as in low voltage DC units, a junction box near the Vibraswitch should be used.

#### NOTE

The instrument housing must be sealed at the conduit outlets with a suitable compound or "trap" to prevent infiltration of moisture-laden air or corrosive gases into the housing.

#### NOTE

All instrument installation wiring must be done in accordance with local codes and commonly accepted practices.

#### NOTE

**a)** The products installed in places with environment temperature of 40°C, must have T<sub>cable</sub> 90°C indication. This means that the Buyer and/or the User must use a connection cable having maximum service temperature not lower than 90°C.

**b)** The products installed in places with environment temperature of 55°C, must have T<sub>cable</sub> 105°C indication. This means that the Buyer and/or the User must use a connection cable having maximum service temperature not lower than 105°C.

To avoid unnecessary difficulty in wiring the unit, the following procedure should be followed in detail:

- When installing conduit and mounting the Model EURO 366, it is recommended that the cover be left on the unit.
- If the Model EURO 366 is to be mounted in unprotected or dusty areas, a dust-tight or water-tight seal should be made at the conduit entrance.

- c. With all mounting complete, remove cover and insert wires through conduit entrance with sufficient length to reach the terminal block.
- d. Strip wires back approximately 6,4 mm (1/4") and install solderless terminals.
- e. Connect wires to terminals as shown in Figure 3-1.

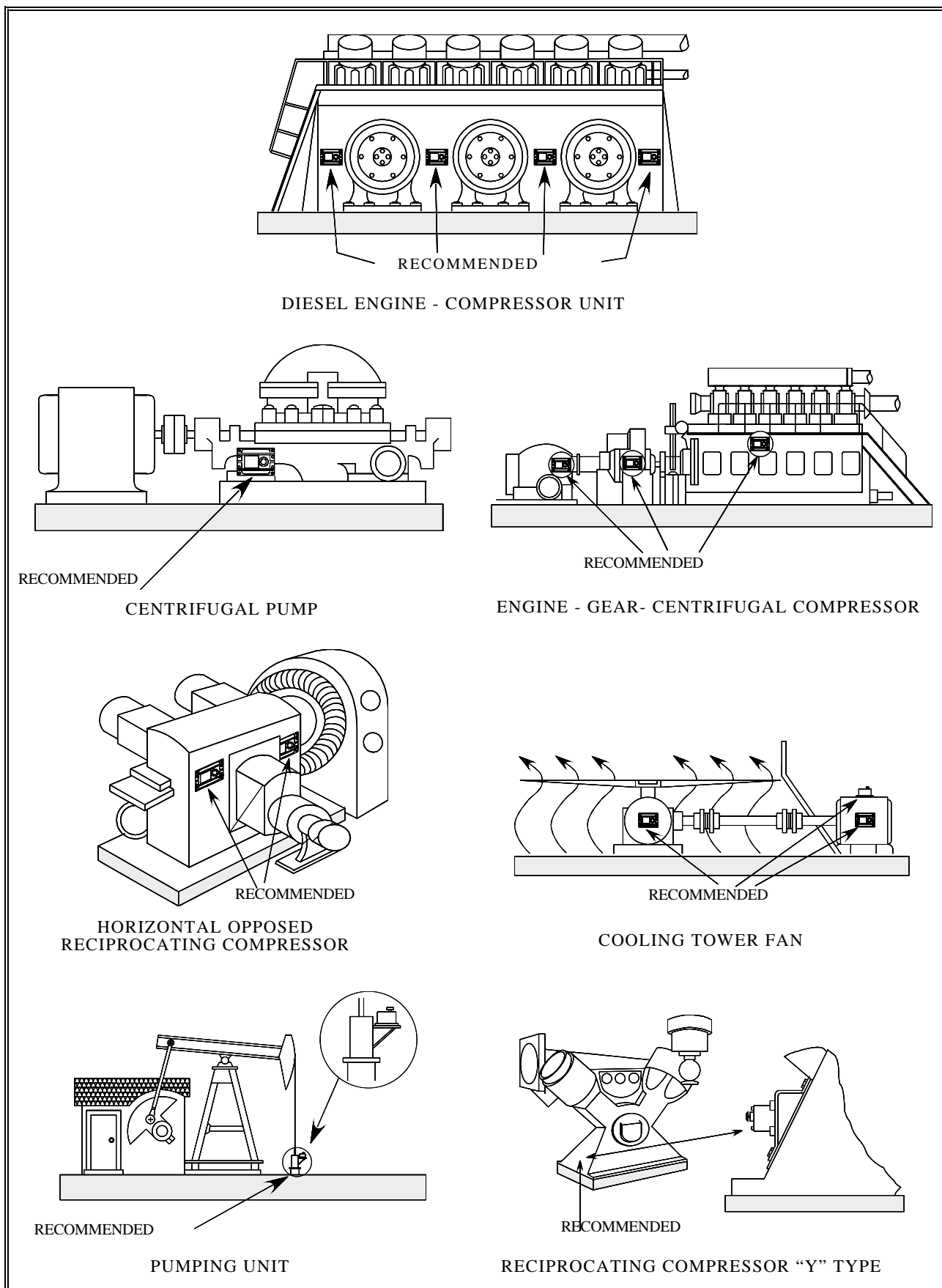

**Figure 3-2** Methods of Mounting the Vibraswitch, Model EURO 366

3.6 MOUNTING DIMENSIONS

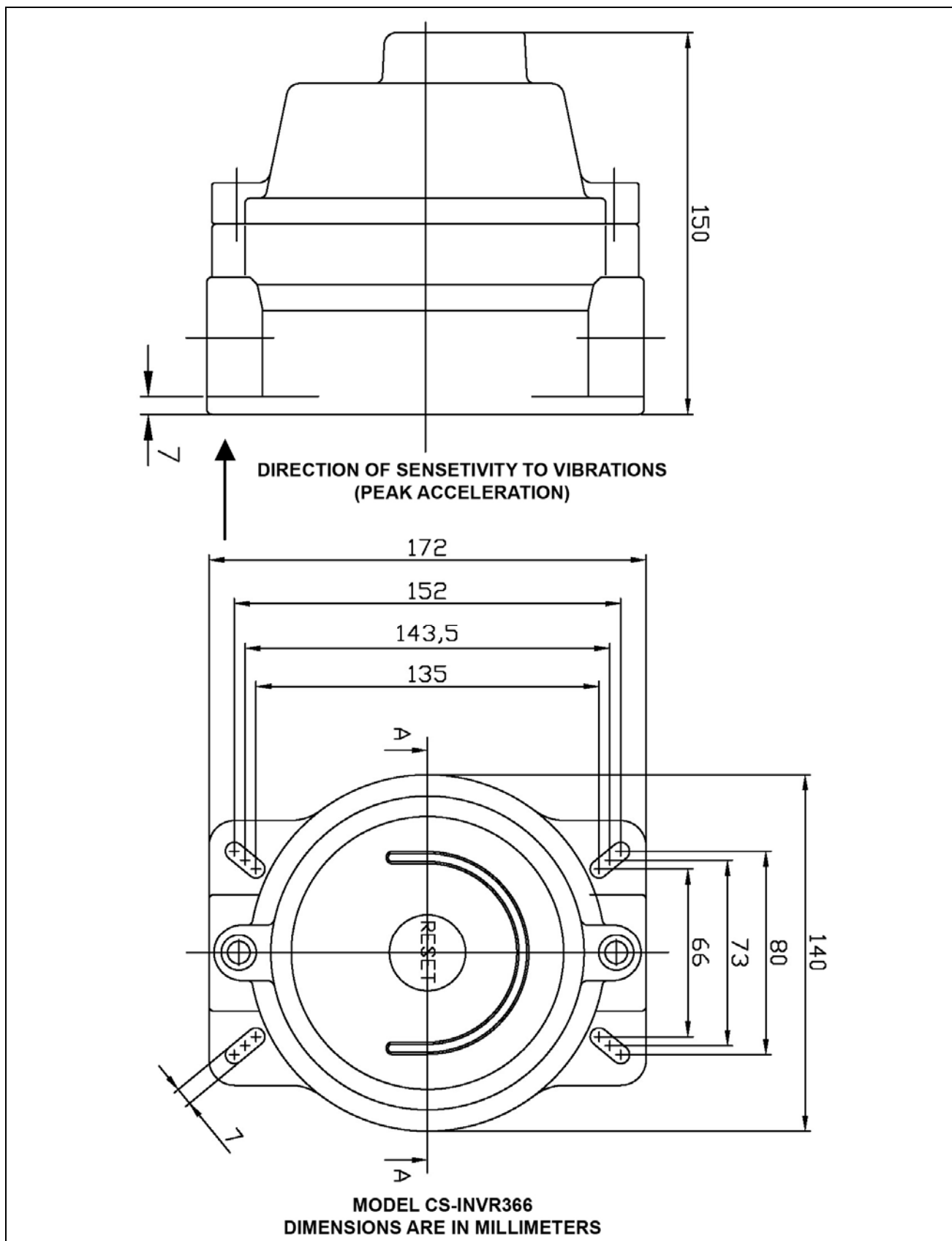
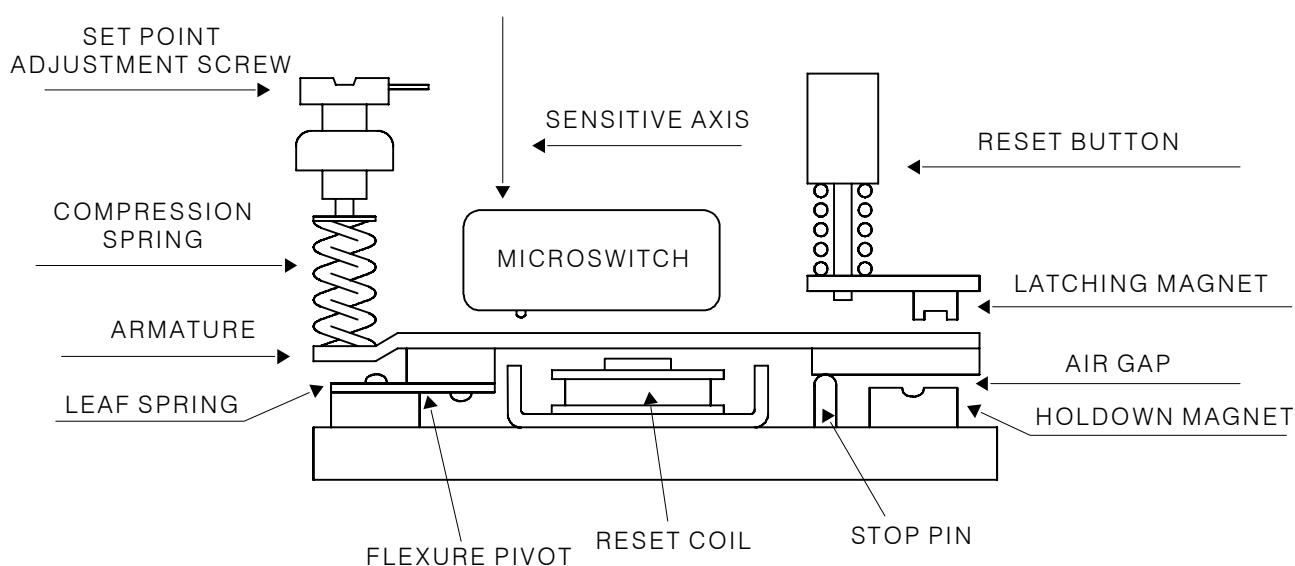

Figure 3-3 Mounting Dimensions for the VibraSwitch

## SECTION IV OPERATION

### 4.1 OPERATION

The Vibraswitch, Model EURO 366 (Refer to Figure 4-1), is sensitive to vibration in a direction (the sensitive axis) perpendicular to its mounting base. It contains a vibration detecting mechanism, which also functions as a “mechanical amplifier”, to activate a snap-action switch when the selected level of vibration is exceeded and the detecting mechanism “trips”.



**Figure 4-1** Operating Principle for the Vibraswitch, Model 366.

The detecting mechanism consists of an armature suspended on a flexure pivot which is restrained from motion by a permanent magnet (the holddown magnet). In the “armed” condition, the armature is held against the stop pin by the holddown magnet. The stop pin maintains a precise air gap between the armature and the holddown magnet. On the opposite end of the armature, the compression spring provides an adjustable force to oppose the force of the holddown magnet. Whenever the peak vibration inertial force (mass x acceleration) plus the adjustable compression spring force exceeds the force of the holding magnet, the armature is released and is pulled into the latching magnet (“tripped” position). Simultaneously, it activates the snap-action switch. This detecting mechanism has a uniform response from 0 to 300 Hz over a range of 0 to 4.5 g’s.

The mechanism may be reset to the “armed” position manually (locally) or electrically (remotely). Manually, depress the reset button to move the armature away from the latching magnet (“tripped” position) until it is held against the stop pin (“armed” position). Electrically, the reset coil may be activated to pull the armature into the “armed” position against the stop pin.

A reset and holding coil is provided, in the DC/AC voltage as specified, so that accidental shutdowns on starts can be prevented. External time-delay circuits are required to maintain voltage at the holding coil during the startup period and then release this voltage when operation is normal. At full voltage, the reset coil should not be energized for more than four minutes to prevent overheating. Then, the reset coil must be de-energized for a period of 10 minutes before re-energizing. For longer hold-in requirements the reset coil should be energized at a full voltage and then held-in at one-half the rated voltage.

The Vibraswitch, Model EURO 366, may be used in conjunction with the Vibraswitch Monitor, Model 563A. The monitor is a solid-state electronic system designed to “sort-out” false signals received by the Vibraswitch so that Alarm and/or Shutdown of the operating machine will not result from false, transient disturbances, but any continuous vibration level which exceeds the Setpoint of the Vibraswitch will cause Alarm or/and Shutdown. Examples of transient disturbances are the closing of pipeline check valves on pumping applications, the start-up of additional pumps on a line, and the initial start-up of various operating machines. These disturbances may cause the Vibraswitch to “trip-out” if the vibratory shock level is in excess of its setpoint. Please note that the Model 563A does not have CE or ATEX certification at this time.

## 4.2 ADJUSTMENT OF OPERATING SETPOINT

The operating setpoint for the Vibraswitch varies with the type of machine and its location (measurement point) on the machine. The setpoint adjustments suggested in this instruction manual are for machines which are functioning in a “good” or “normal” condition. This method follows the concept of vibration tolerance for the machine and in this case is dependent upon an individual who is experienced in the operation of the machine to define the vibration as “normal”, “fair”, “slightly rough”, etc. These various degrees of machine vibration are, therefore, based on individual’s physical perception between normal and abnormal roughness while the machine is operating.

It is agreed that this method can lead to differences in the classification of degree of vibration between individual observers. It is Robertshaw’s contention, and experience bears out this conclusion, that if the machine is operating satisfactorily as previously defined and the acceleration as measured by the Vibraswitch is within certain limits, the settings as outlined in the instructions will offer protection to the machine and prevent catastrophic failure.

For example, assume that a relatively new machine which, in the experience of the operator, is operating as “smooth” or “good” regarding vibration and the Vibraswitch measures this acceleration level to be 0.25 g above its static condition (zero). Experience suggests that a reasonable level for alarm conditions would be a minimum of twice this value or 0.5 g. It must be acknowledged that such a definition or upper vibration limits (alarm condition) on the machine may not have adequately defined the upper tolerance limit of the machine before major repairs or excessive machine damages occurs. It does, however, define a limit which, in our experience, has proven to be safe. As the user becomes more adept in using the Vibraswitch as a monitoring device, his experience may dictate an higher setpoint more in keeping with the experience he has gained on the particular machine.

The Model EURO 366 Vibraswitch is adjusted by a simple three-step procedure. In making these measurements the cover must be removed to gain access to the Setpoint adjusting screw. (Ref. Figure 4-2.)

### a. Zero Vibration Level Measurement

With the equipment on which the Vibraswitch is mounted not operating, back off the Setpoint adjusting screw counterclockwise (CCW) two turns and press the reset button. Then turn the Setpoint adjusting screw slowly clockwise until actuation occurs (the armature assembly is against the latch magnet, Figure 4-1). This is the zero vibration point, or actuating point, with the machine not operating. A mark should be made with a lead pencil or other convenient means to permanently record this “zero vibration point”. Subsequent measurements are made relative to this point.

b. Normal G-Level Measurement

With the machine (equipment) operating, back off the Setpoint adjusting screw one turn CCW and reset. If it will not reset, back off the Setpoint adjusting screw two turns CCW, etc. Again turn the Setpoint adjusting screw slowly clockwise until actuation occurs. Mark this position with a lead pencil or other convenient means. The difference between the two actuating points in Steps a and b is the normal g-level of the operating machine, in scale divisions. One scale division is 0.1 g; one full revolution is 1.0 g.

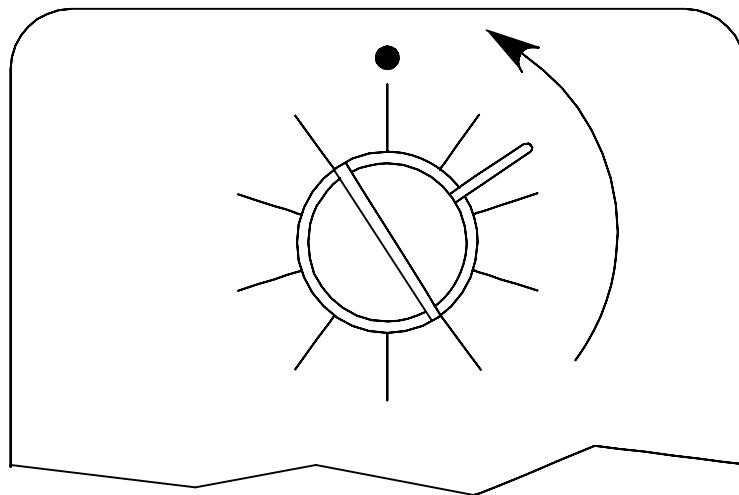

**Figure 4-2** Setpoint Adjustment

c. Final Setpoint Adjustment

If the “normal” g-level is less than 1.0 g above the zero level, rotate the Setpoint adjusting screw CCW 0.5 g (five graduations) from the point where actuation occurs in Step b above. If the “normal” g-level is greater than 1.0 g refer to Figure 4-3 for the proper Final Setpoint setting with respect to the “normal g-level vibration point” obtained in Step b. See example on Figure 4-3.

**NOTE**

In the preceding adjustments, actuation can be heard as an audible “click”. In very noisy surroundings, it may be necessary to use an ohmmeter or wire the Vibraswitch to the control circuit to tell when actuation occurs or observe visually that the armature is in the up (latched) position.



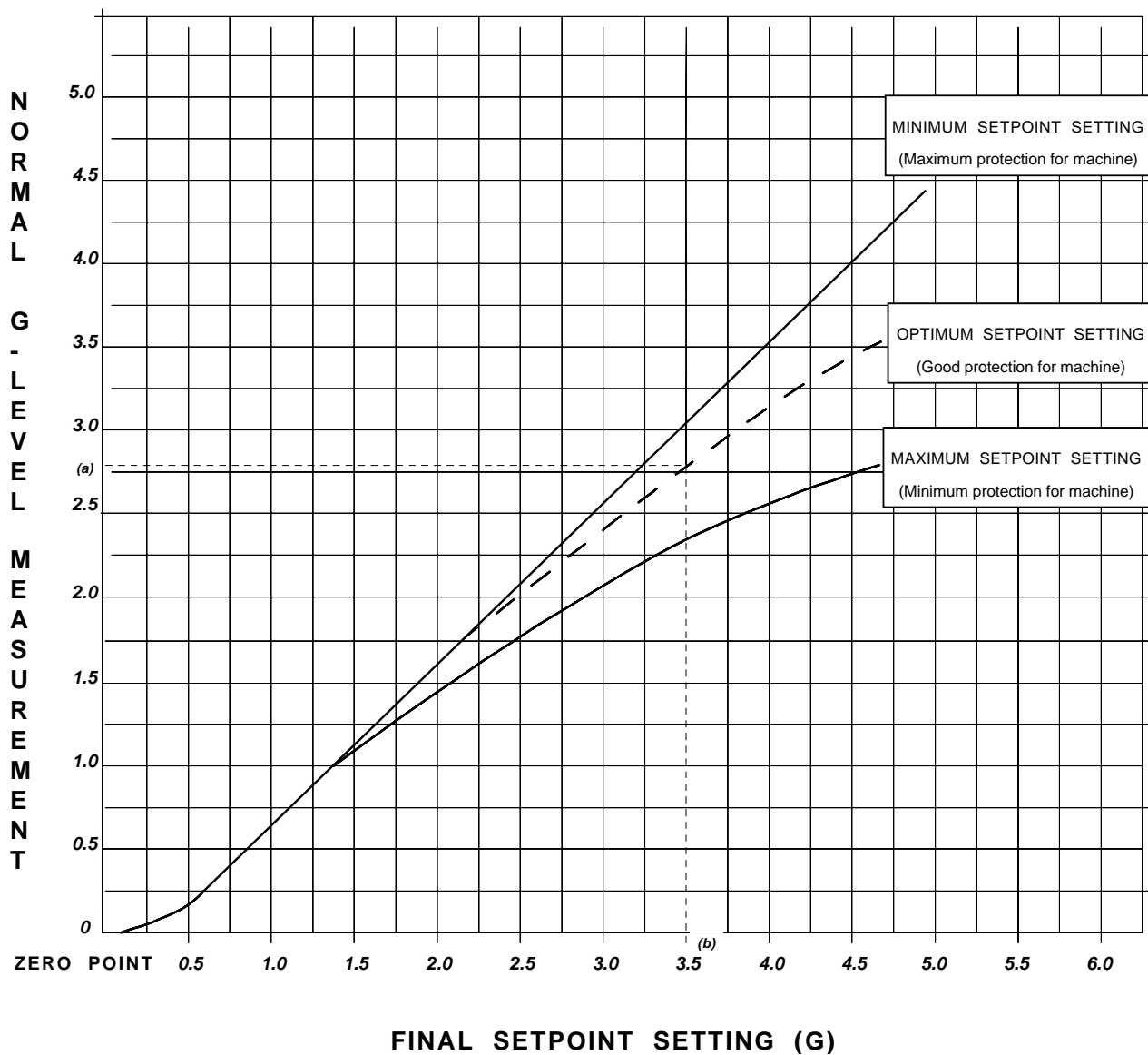

Example: If the Normal G-Level (a) is 2.8 g above the Zero Vibration Level, the Final Setpoint Setting (b) should be set at 3.5 g above the Zero Vibration Level. Therefore, advance the Setpoint Pointer CCW 0.7 g ( $3.5 \text{ g} - 2.8 \text{ g} = 0.7 \text{ g}$ ) or 7 divisions (one scale division is 0.1 g) from the Normal G-Level.

**Figure 4-3** Setpoint Alarm settings.

## SECTION V MAINTENANCE

### 5.1 TROUBLESHOOTING

Vibraswitches do not normally require any maintenance or repair, however, listed below are some of the possible malfunctions that may occur and their recommended solutions (Ref. Figure 4-1). Perform all tests with field wiring disconnected.

#### a. Functional Test - (Ref. Figure 4-1)

1. With the Vibraswitch cover removed, place Vibraswitch on a table with its mounting surface down.
2. Press reset button. If switch does not reset (armature latched on stop pin), turn set point adjustment screw CCW until switch can be manually reset.
3. Slowly turn set point adjustment screw CW until switch trips. This is the zero trip point which is the amount of spring tension required to overcome the 1 g force exerted by the earth's gravitational pull.
4. Note set point setting. One complete turn equals approximately 1 g. Set point scale is marked in 0.1 g increments. Turn set point adjustment screw 1 complete turn CCW. This is a 1 g setting above the earth's gravitational pull.
5. Manually reset the switch (press reset button).
6. With the reset button to your right and the set point adjustment screw to your left, slowly rotate the Vibraswitch toward you 90°. The switch will trip when the mounting surface is in a vertical plane and the earth's gravitational pull is not aiding the lower magnet to hold the armature against the stop pin.

#### b. Vibraswitch Will Not Reset

1. Dirt and/or iron metal chips on magnets.  
clean magnets.
2. Broken leaf spring - (Ref. Figure 4-1).  
Return the Vibraswitch to the factory for repair.
3. Open reset coil.  
Check for continuity or proper coil resistance (Ref. Table 5-1).

**TABLE 5-1** Coil Resistance

Nominal Voltage	Resistance (Ohms $\pm$ 10%)
24 VDC	50
48 VDC	230
120 VDC	840
120 VAC	Check for continuity*
240 VAC	Check for continuity*

\* (Diode prevents actual resistance reading)

c. Unable to Adjust Setpoint Setting to Obtain Tripping

Improper air gap between Holddown (lower) Magnet and Armature.  
Return the Vibraswitch to the factory for repair.

d. Switch Does Not Actuate

Defective or improperly adjusted switch - (Ref. Figure 4-1).

Manually move the Armature between the hold down magnet (armed position) and latching magnet (latched position) and listen for an audible click of the switch. An audible click occurs when contacts change state. Verify by performing a continuity check. Return the Vibraswitch to the factory for repair.

**NOTE**



If the switch does not pass either of the tests above, return the Vibraswitch to the factory for repair.



## SECTION VI

### SPECIAL ATEX INSTRUCTIONS

#### 6.1 ATEX INSTRUCTIONS

##### Command, Signalling and Visualisation Units series CS ...

Execution :   II 2G, II 2GD      Ex d IIB/IIC T6, Ex d IIB/IIC T6 d) A21 IP66 T85°C

  IM2      Ex d I

Standard Compliance: EN 60079-0:2006, EN 60079-1:2004, EN 61241-0:2006, EN 61241-1:2004

EC type Certificate: CESTI 03 ATEX 186

#### 1. Safety instructions

This safety instructions refer to the fitting, use and maintenance of the command, signalling and visualisation units series CS ... for use on surface areas and underground in an explosive atmosphere due to dusts, gas and vapours.

The appliances included in the present instruction sheet are protected against risk of explosion as described hereafter.

Type of protection	Category	Standard Amb. Temp.	Special Amb. Temp.
Ex d IIB/IIC T6 - Ex d IIB/IIC T6 d) A21 IP66 T85°C	II 2G - II 2GD	-20°C++40°C	-20°C++60°C
Ex d I	IM2		-40°C++60°C (not for Gr. IM2) -40°C++40°C (not for Gr. IM2)

The above type of protections can be combined whenever required by different hazardous circumstances.

#### 2. Installation and electrical connection

##### 2.1 Compatibility between the appliances and the hazardous areas

According to the technical and legislative regulations the housing can be installed in explosive areas. The appliances must be fitted in a compatible area under the user's responsibility.

Essential health and safety standards for protection against explosive atmospheres in classified areas are set in European Directive 94/9/EC (for equipments) and 1992/92/EC (for plants).

Criteria for classification of areas with presence of explosive atmosphere are set in standard EN 60079-10 for gas presence and EN 50281-3 for flammable dust presence.



Technical standards for electrical installations in classified areas are set in standard EN 60079-14 for gas presence and EN 50281-1-2 in case of flammable dust presence.

In the label, with functional data, there is reference to Notified Body responsible for production surveillance and certification.

WARNING: the appliance can not be installed in "ZONE 0" and in "ZONE 20".

##### 2.2 Label data

Label data that identify safety characteristics of equipment and compliance to relevant standards are the following:

IM2	Equipment for mines with presence of grisoutose and for surfaces installation of those mines with possible presence of grisou and/or coal dust.
II 2G	Category 2 equipment for surface installation of gas and vapour, suitable for Zone 1 and redundant for Zone 2.
II 2D	Category 2 equipment for surface installation in presence of flammable dust, suitable for Zone 21 and redundant for Zone 22.
II 2GD	Equipment for surface installation combining category II 2D and II 2G.
IIB	Equipment suitable for gas group IIB.
IIC	Equipment suitable for gas group IIC.
T6	Equipment temperature class (max. surface temperature).
IP66	Mechanical protection degree according to EN60529.
T85°C	Max surface temperature in presence of dust.
 nnnn	Conformity to relevant EC standards and number of Notified Body responsible for production surveillance.
	Conformity to 94/9/EC Directive and related technical standards.
CESTI xxATEXyyyy	Notified Body issuing EC Type Certificate, xx = year of certificate; yyyy = number of certificate.

Notes:

- a) The appliances of IIC group are also suitable for IIA, IIB areas; appliances of group IIB are also suitable for IIA areas
- b) The appliances with temperature class T6 are also suitable for all the substances with higher temperature class (T5, T4, T3, T2, T1).
- c) The appliances with temperature class 85°C (category 2D) are also suitable for all the substances with higher temperature class.

2.3 Marking

The manufacturer and product identification initial together with the functional and certification details must be printed on a plate or directly on the housing.

The initial printed on the plate identify the following code:

a) Switch:

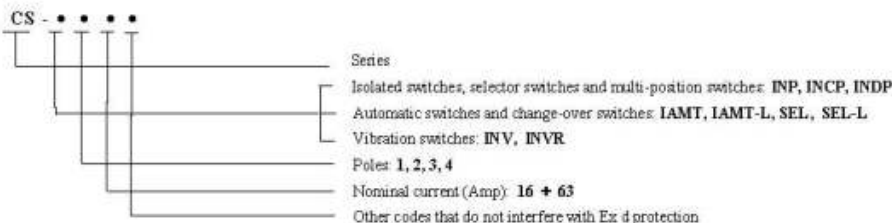

b) Vibration switch:

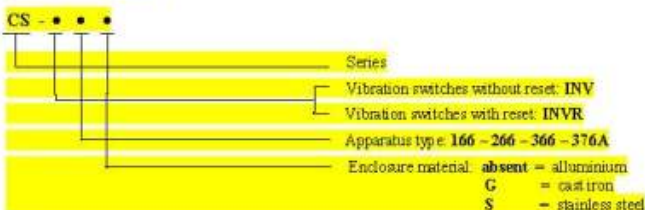

c) Push button panels and signalers:

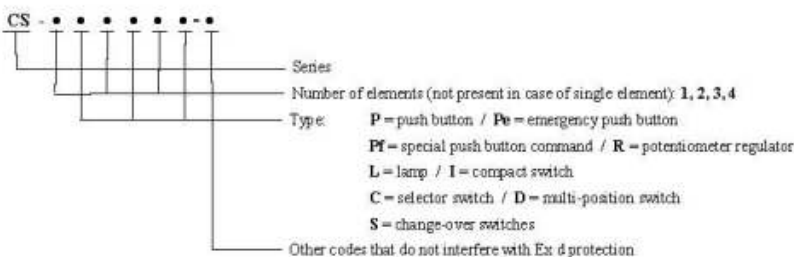

d) Limit switches:

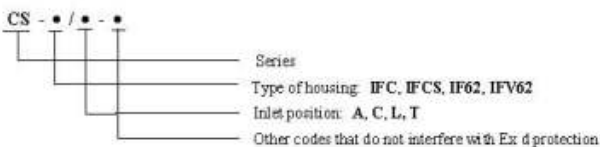

e) Instrument housing:

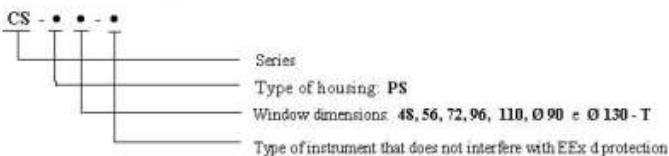

## 2.4 Installation

The appliance can be fitted only by skilled personnel.

The flat [X], [I] and cylindrical [Y] joints, which meet the safety requirements, must not come into contact with tooling, dusts or other types of material which could damage them. When closing the appliance please make sure that the joints are clean and protected with silicon grease.

Make sure that the threaded cover is properly locked with the locking screw (1a).

While the cover with the cylindrical joints must be locked through the two allen screws (1b) with the appropriate wrench.

If an o-ring (2), is fitted in order to ensure the mechanical protection, check that it has not been damaged during the assembly and is duly protected by silicon grease.

The integrity of the (2) is essential to meet the safety requirements of the appliance during the 2 GD execution.

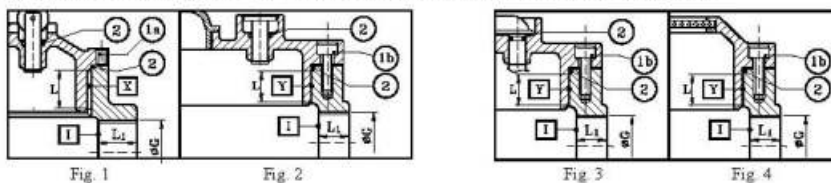

## 2.5 Cable entries

The connections must be carried out through the cable inlets in accordance with EN 60079-14 standards with the aid of certified appliance and/or components in accordance with EN 50014 and EN 50018 European standards. As far as the appliance type and degree are concerned, they must be in accordance with the 94/9/EC regulation. Do not add any gasket unless provided by the manufacturer.

## 2.6 Electrical connections

Remove the cover by unscrewing the locking screws before carrying out the electrical connection.

The connection to the electrical circuit must be carried out by connecting the suitable terminals with an electric wire according to the CEI EN 60079-14 standards, with a type of section not exceeding the max section of the connecting terminal.

Once connected close the cover and lock the screws.

The housing must be connected to the equipotential ground system through the appropriate earth connection.

## 3. Usage and maintenance

### 3.1 Usage

The appliance must be fed with the voltage not exceeding the one indicated on the plate positioned outside the housing.

### 3.2 Maintenance

The appliance must be periodically maintained by skilled personnel only.

Check the o-ring if assembled. In case of deterioration, ask the manufacturer to replace it.

Protect the joint with silicon grease after each check up and maintenance.

Any modification to the joint both for oxidation and accidental damage must contemplate the housing removal for a proper check up, preferably at the manufacturer's premises, by skilled technician.

The internal appliance can be replaced only with original spare parts, any modification of the internal electrical circuit is forbidden and removes the manufacturer from responsibility.

Any repair to the housing is forbidden. In case of need please contact the Customer Service.

## 4. Technical Characteristics

### 4.1 Electrical circuit

The appliance mentioned in the "Unit type" column, has the following electrical characteristics:

Unit type	ELECTRICAL CHARACTERISTICS
Isolated switches and limit switches	Max nominal voltage: 125 V.c.c. / 660 V.c.a. - Max current: 63 Amp. ; Nominal frequency: 40 - 60 Hz
Push button panel and signalling	Max nominal voltage: 125 V.c.c. / 660 V.c.a. - Max current: 10 Amp. ; Nominal frequency: 40 - 60 Hz Max lamp power: 5W Max lamp power: 2W (in environment temp. +60°C)
Instrument housing	Max nominal voltage: 125 V.c.c. / 450V.c.a. - Max current: 5 Amp. ; Nominal frequency: 40 - 60 Hz
Potentiometer regulator	Max nominal voltage: 300 V.c.c. / c.a. - Max power: 3 Watt. - Max resistance: 10 kΩ

For any further details please contact the Customer Service.



IMC-024/03.11 rev. 00 dated April 7th, 2008



**Robertshaw Industrial Products**  
**1602 Mustang Drive**  
**Maryville, Tennessee 37801**  
**Phone: (865) 981-3100 Fax: (865) 981-3168**  
**<http://www.robertshawindustrial.com>**

(04/09)

Printed in U.S.A.